

®

**AYDE**

**KARE KÜPEŞTE PROFİLLERİ**

SQUARE PROFILES HANDRAIL

**14046**

0,998 kg / mt

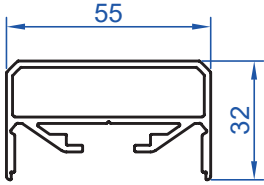

**14146**

0,863 kg / mt

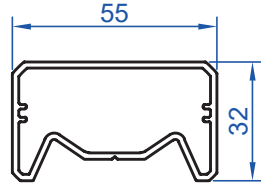

**14149**

0,937 kg / mt

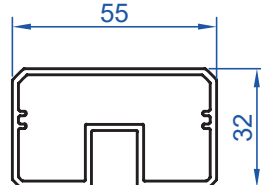

**14035**

1,298 kg / mt

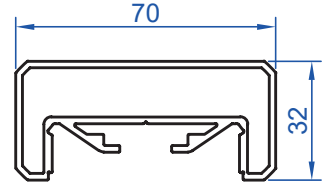

**14147**

1,135 kg / mt

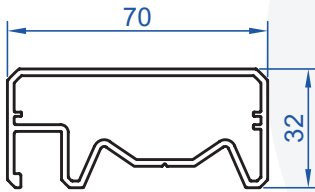

**14148**

1,105 kg / mt

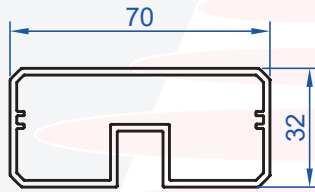

**14151**

1,364 kg / mt

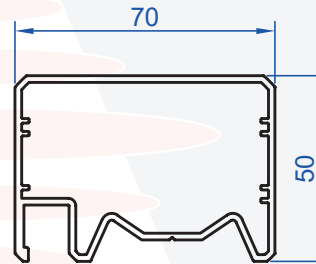

**14036**

0,345 kg / mt

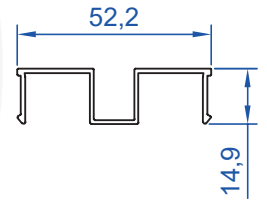

**14037**

0,277 kg / mt

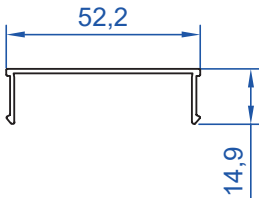

**14034**

1,154 kg / mt

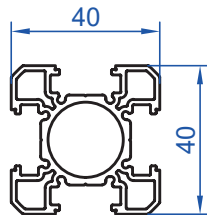

**14057**

1,033 kg / mt

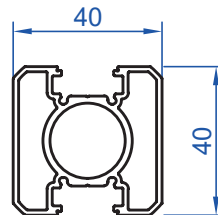

**14150**

0,892 kg / mt

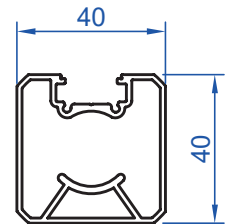

**14033**

0,086 kg / mt

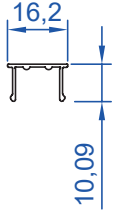

**14103**

0,077 kg / mt

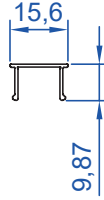

**14041**

0,695 kg / mt

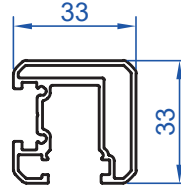

**14042**

0,070 kg / mt

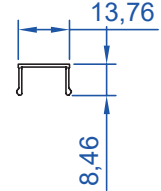

**14056**

0,210 kg / mt

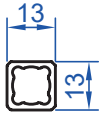

**14051**

0,282 kg / mt

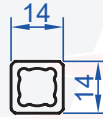

**14157**

0,615 kg / mt

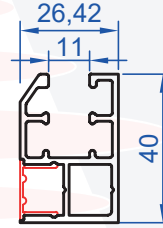

**14055**

0,942 kg / mt

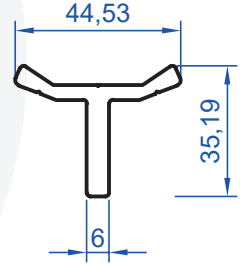

**14155**

0,995 kg / mt

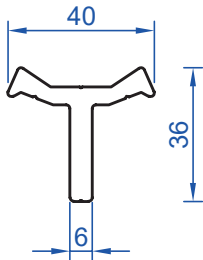

**14054**

3,322 kg / mt

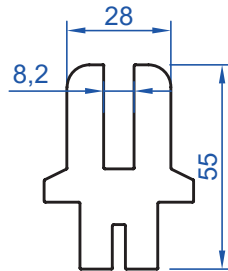

**14154**

2,447 kg / mt

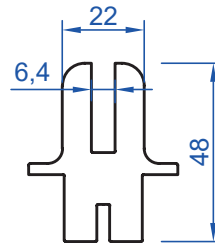

**14073**

0,846 kg / mt

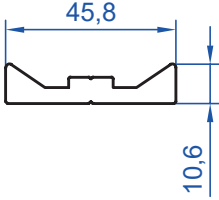

**14153**

0,622 kg / mt

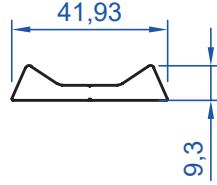

**14040**

1,022 kg / mt

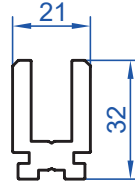

**14096**

0,605 kg / mt

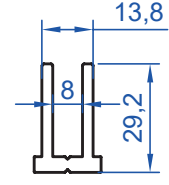

**14095**

1,987 kg / mt

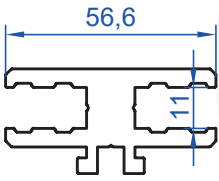

**14047**

1,232 kg / mt

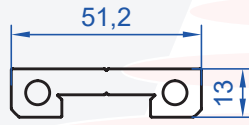

**14059**

2,010 kg / mt

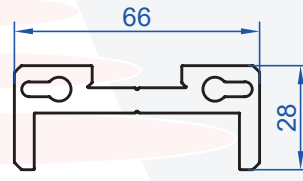

**14158**

1,044 kg / mt

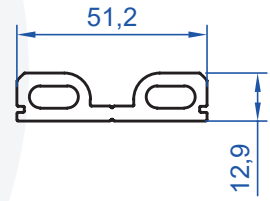

**14152**

1,206 kg / mt

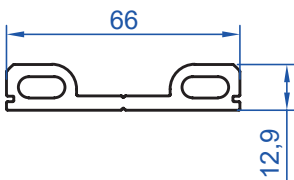

**14038**

4,763 kg / mt

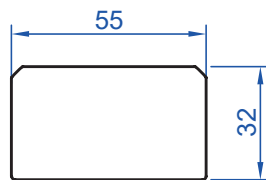

**14039**

6,040 kg / mt

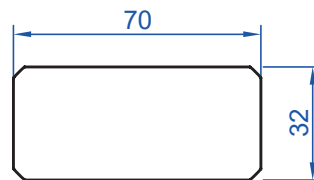

**14156**

0,707 kg / mt

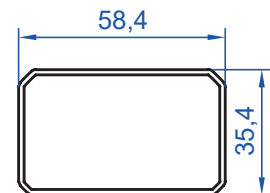

**14079**

0,847 kg / mt

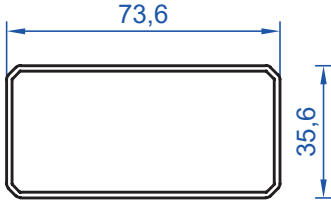

**14052**

4,315 kg / mt

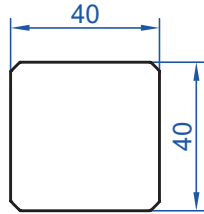

**14050**

0,536 kg / mt

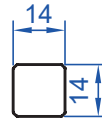

**14062**

3,456 kg / mt

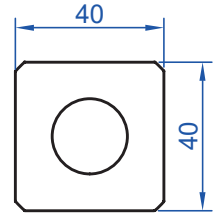

**14044**

1,529 kg / mt

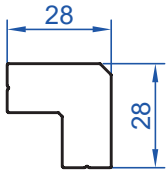

**14045**

1,672 kg / mt

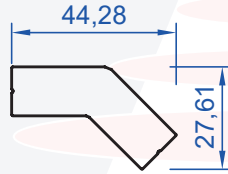

**14074**

1,396 kg / mt

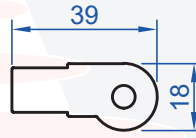

**14043**

3,394 kg / mt

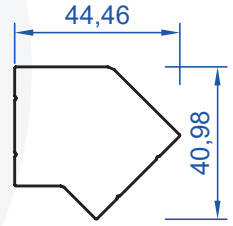

**14063**

2,564 kg / mt

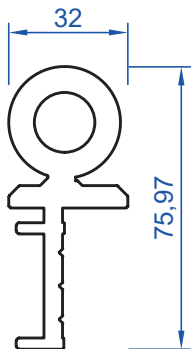

**14072**

6,217 kg / mt

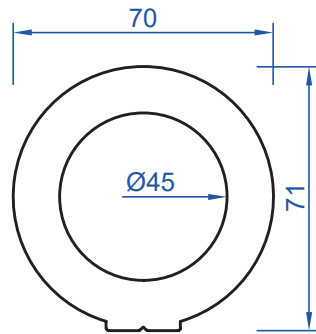

**14075**

3,217 kg / mt

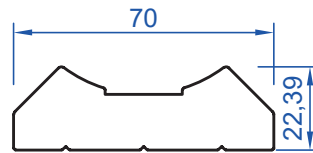

**14053**

4,122 kg / mt

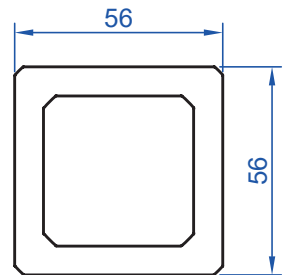

**14049**

8,055 kg / mt

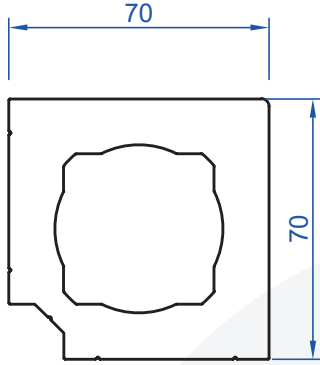

**14048**

10,172 kg / mt

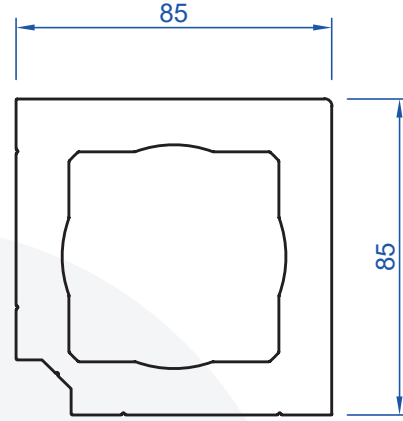

**14086**

2,193 kg / mt

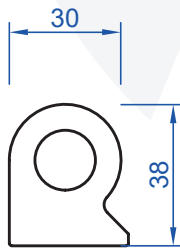

**14166**

7,416 kg / mt

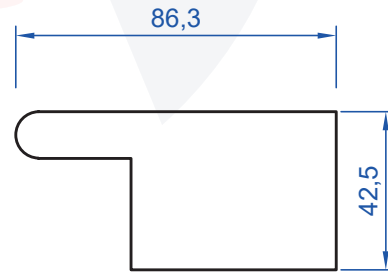

**50717**

1,306 kg / mt

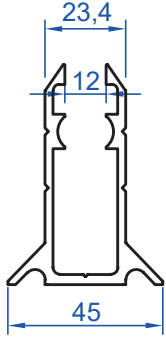

**14135**

1,669 kg / mt

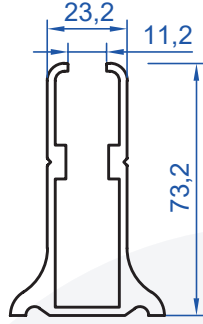

**50777**

1,667 kg / mt

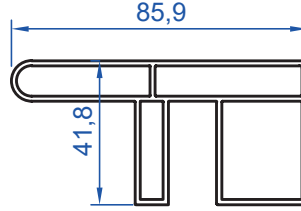

**14162**

1,430 kg / mt

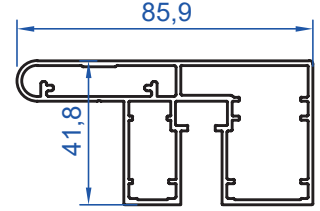

**14163**

0,792 kg / mt

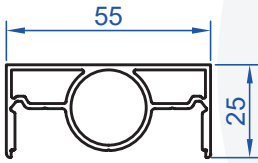

**14164**

0,781 kg / mt

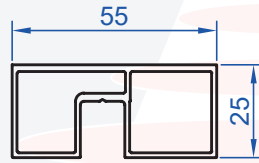

**14165**

1,173 kg / mt

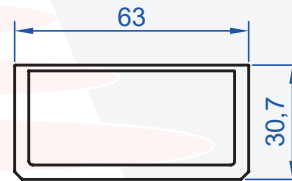

**14159**

1,461 kg / mt

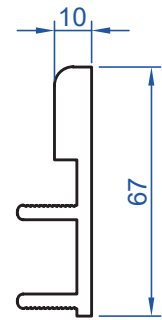

**3014**

0,244 kg / mt

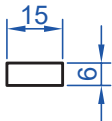

**14169**

1,250 kg / mt

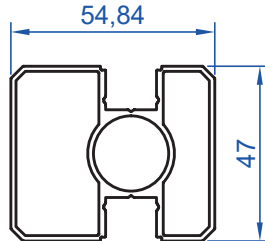

**14170**

2,321 kg / mt

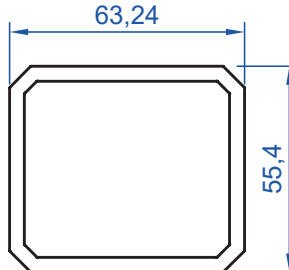

**14168**

1,793 kg / mt

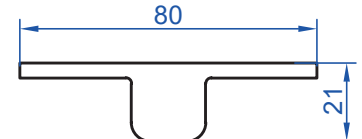

**14171**

3,270 kg / mt

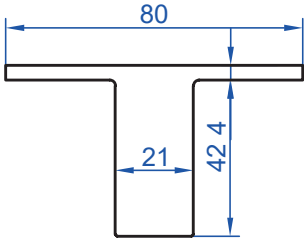

**14188**

1,090 kg / mt

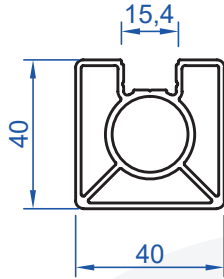

**14189**

0,524 kg / mt

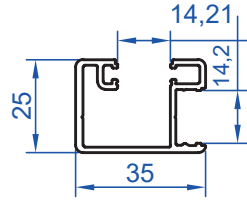

**14190**

0,839 kg / mt

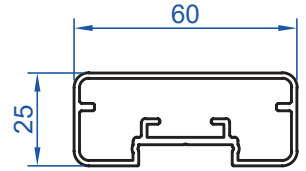

**14191**

0,872 kg / mt

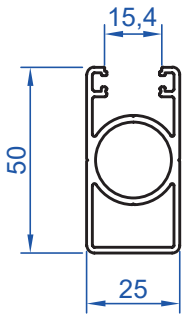

**14192**

0,084 kg / mt

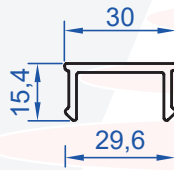

**14193**

1,150 kg / mt

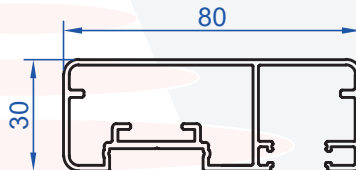

**14200**

0,993 kg / mt

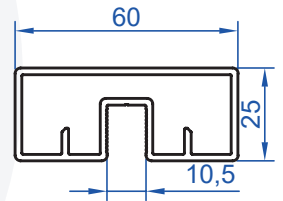

**14203**

0,480 kg / mt

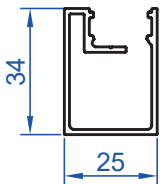

**14204**

1,622 kg / mt

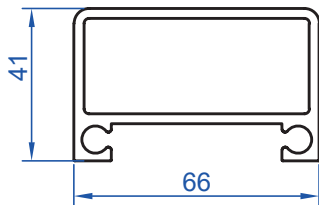

**14205**

1,989 kg / mt

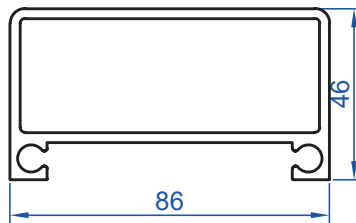

**14206**

1,947 kg / mt

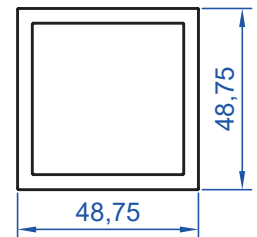



**14207**

1,794 kg / mt

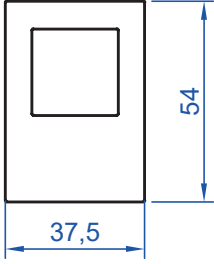

**14208**

4,349 kg / mt

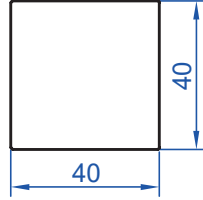

**14209**

1,170 kg / mt

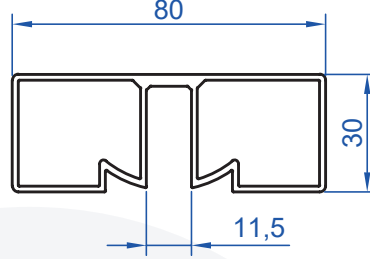

**14210**

1,015 kg / mt

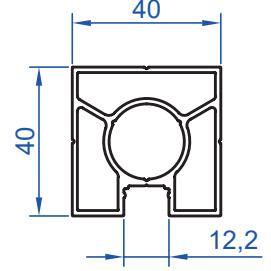

**14211**

0,069 kg / mt

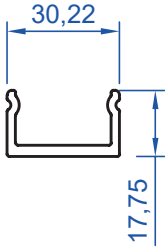

**14213**

0,582 kg / mt

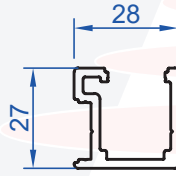

**14214**

0,069 kg / mt

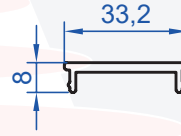

**14215**

0,296 kg / mt

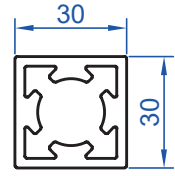

**51202**

0,833 kg / mt

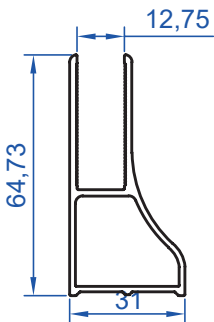

**51124**

1,415 kg / mt

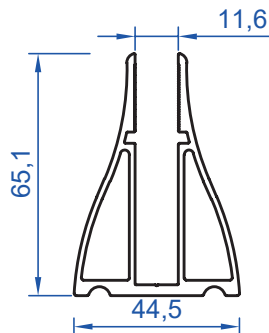

**14240**

1,036 kg / mt

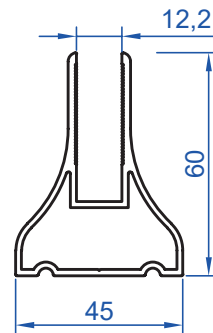

**14216**

0,770 kg / mt

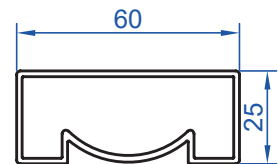

**14217**

0,971 kg / mt

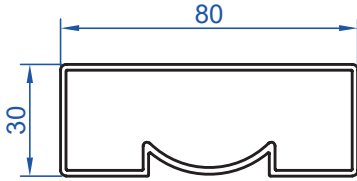

**14218**

1,216 kg / mt

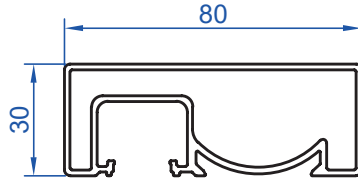

**14219**

0,933 kg / mt

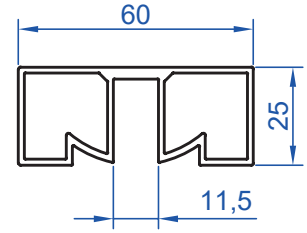

**14220**

0,911 kg / mt

